

TEMP110032021MAN

UK/EU English

EVOLUTION
AQUA

INNOVATION IN WATER

tempest

Innovative Polisher For Ponds

INSTRUCTION MANUAL

IMPORTANT:

Ensure slide valves are fitted to inlet and outlet of all Tempest filters.
Read the instructions carefully before carrying out the installation.

ABOUT THE TEMPEST FILTER

The **Tempest filter** is an **innovative polishing system** for ponds that will help to deliver **crystal clear water**. Designed to be used in conjunction with **any filtration system**, the Tempest offers **additional mechanical** and **biological filtration**. The Tempest filter can also be used on **quarantine systems** or as a **standalone filter** on smaller ponds up to **5,000 Litres / 1,100 Gallons / 1,320 US Gallons**.

The Tempest filter is **easy to install** and is **simple** and **quick to clean**, by way of a unique, **patent pending air syphon design**. During the cleaning process, air is drawn into the filter as it empties which causes the water to agitate, effectively cleaning the **K+Media**.

Using Evolution Aqua's **K+Media** as the filter media, particles down to **one micron** can be filtered. On a single pass, testing has proven our media capable of removing all particles down to **25 micron** when used at the optimum flow rate. Not only that, **K+Media** is the result of extensive research and development and is moulded with **minerals** for **faster maturation times**.

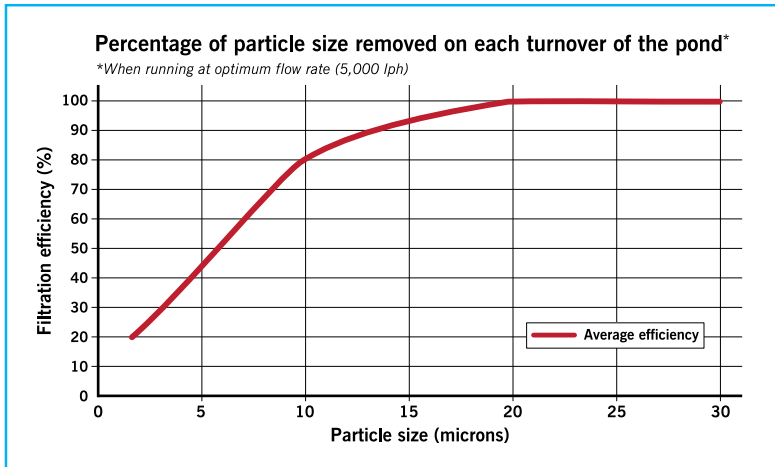

Evolution Aqua filter media has been independently tested by **IFTS (Institut de la Filtration et des Techniques Séparatives)**.

IFTS International Filter Testing Services is the international reference for solid-liquid separation. Founded in 1981, IFTS is an independently regulated, ISO 17025 accredited, laboratory and research center focusing on liquid filtration and separation science. IFTS quality management system is certified to ISO 9001:2015.



K+MEDIA

K+Media is designed and manufactured by Evolution Aqua. This advanced media, with its **innovative design** and **class leading surface area** provides enhanced biological and mechanical filtration. As Evolution Aqua extrude the **K+Media**, minerals and enzymes are added to the raw material.

The result of this process, unique to Evolution Aqua, is a filtration media that not only outperforms most of its competitors due to its **large protected surface area**, but also answers the problem of how to speed up the time taken to mature your filter.

- Class leading total surface area 1350m² per m³
- Vast protected surface area 1025m² per m³
- Filters mature faster with K+ Media
- Minerals incorporated into each piece during extrusion
- Unique design for stable bio-film development
- Exceptional solids removal

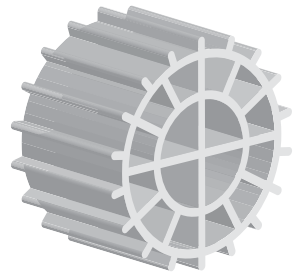

K+Media

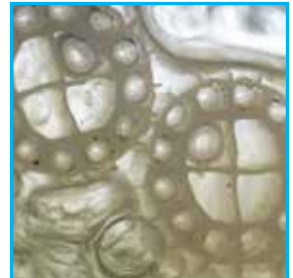
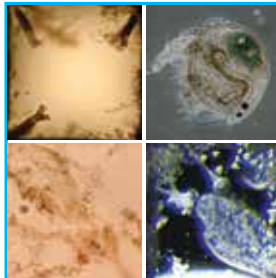

TEMPEST FILTER PARTS



**Tempest Filter filled with
7 litres of K+Media**



Waste Valve Assembly



**1 1/2" Slide Valve
Qty x 2**



**100mm 1 1/2" Connector Pipe
Qty x 2**



**1 1/2" Pipe Clip Bracket
Qty x 2**

YOU WILL ALSO REQUIRE:

- Solvent Weld Adhesive
(EA Code: S79-0-500)
- Tools and fixings for installation

TEMPEST FILTER OVERVIEW

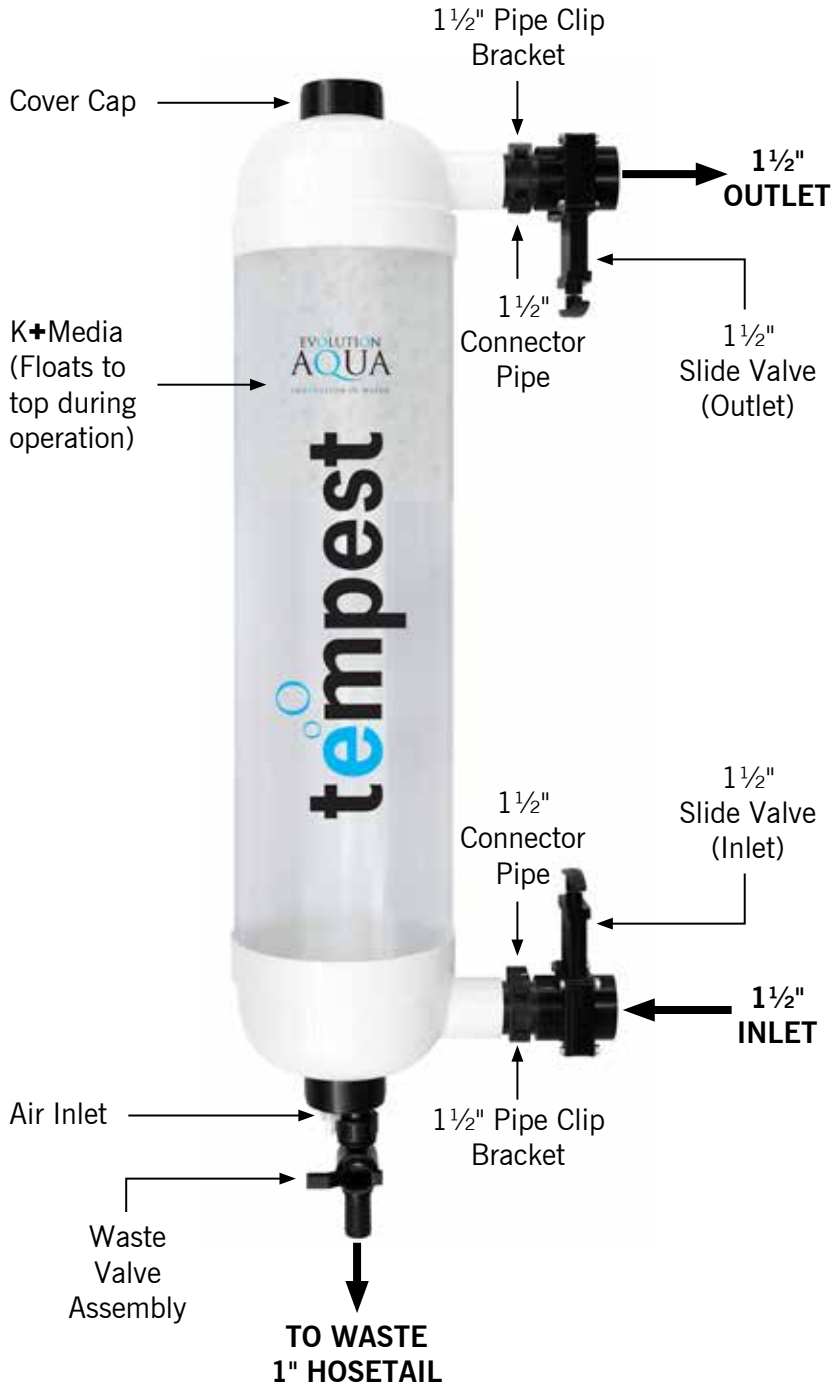

TEMPEST FILTER SPECIFICATIONS

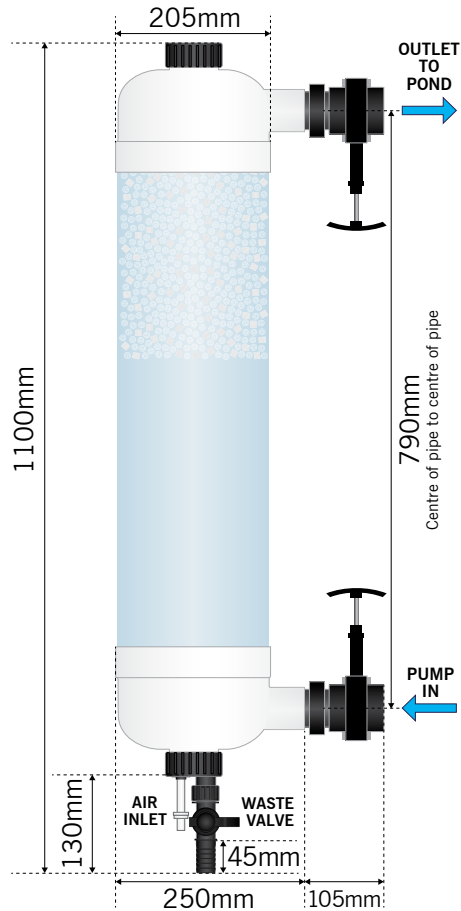

INLET	1½" (UK / USA) / 50mm (EU)
OUTLET	1½" (UK / USA) / 50mm (EU)
DRAIN HOSETAIL SIZE	1" (UK / USA) / 32mm (EU)
MAXIMUM FLOW RATE	7,500 LPH / 1,650 GPH / 1,980 US GPH
OPTIMUM FLOW RATE	5,000 LPH / 1,100 GPH / 1,320 US GPH
K+MEDIA SUPPLIED	7 Litres
WATER VOLUME IN FILTER	27 Litres / 5.9 Gallons / 7.1 US Gallons

The Tempest filter can also be used on quarantine systems or as a standalone filter on smaller ponds up to 5,000 litres / 1,100 gallons / 1,320 US gallons.

TEMPEST FILTER SET-UP

Follow these step by step instructions to set-up your Tempest filter ready for installation.



IMPORTANT: Ensure the supplied o-ring is fitted inside the waste valve assembly before screwing on to waste outlet.

STEP 1: Familiarise yourself with all the components from the parts bag.

STEP 2: At the bottom of the filter, screw on the waste valve assembly hand tight only, do not use tools. **(Ensure the o-ring is seated inside the screw cap)**

STEP 3: Solvent weld one end of the 100mm length of 1½" connector pipe into the inlet of the Tempest. Push pipe into the inlet until it stops.



ADVICE: We recommend having the slide valves face each other, so the top valve points down and the bottom valve points up.

STEP 4: Solvent weld the slide valve onto the opposite end of the 1½" connector pipe. Push slide valve onto pipe until it stops.

STEP 5: Take the second 100mm length of 1½" connector pipe and solvent weld it into the outlet of the Tempest filter. Push pipe into the outlet until it stops.

STEP 6: Solvent weld the slide valve onto the opposite end of the 1½" connector pipe. Push slide valve onto pipe until it stops.

STEP 7: Allow the glue to set for atleast 5 hours.

The Tempest is now set-up ready for installation.

The slide valves fitted allow connection to 1½" pressure pipe.

If installing the Tempest Filter using flexible hose you will need to fit a reducing sleeve (**EA Code: M35-050**) and a 1½" solvent stepped hosetail (**EA Code: HOSETAIL15**) inside each slide valve.

TEMPEST FILTER SET-UP

Follow these instructions to set-up your Tempest filter ready for installation.



IMPORTANT: Ensure the supplied o-ring is fitted inside the waste valve assembly before screwing on to waste outlet (See step 2).



PARTS NEEDED: You will need solvent weld adhesive and a brush for gluing.



STEP 1: Familiarise yourself with all the components from the parts bag.

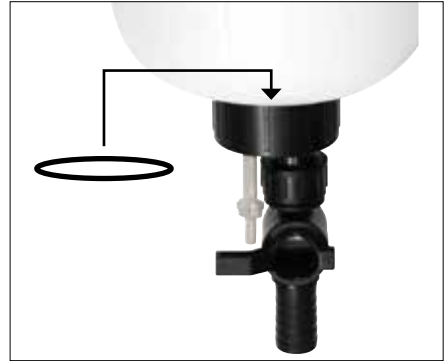

STEP 2: With o-ring in place inside collar, screw on the waste valve assembly to the bottom of the Tempest filter, hand tight only. (Do not use tools)



STEP 3: Solvent weld one end of the 100mm length of 1½" connector pipe into the inlet of the Tempest. Push pipe into the inlet until it stops.

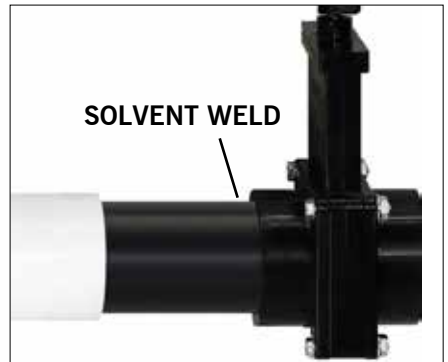

STEP 4: Solvent weld the slide valve onto the opposite end of the 1½" connector pipe. Push slide valve onto pipe until it stops.

TEMPEST FILTER SET-UP

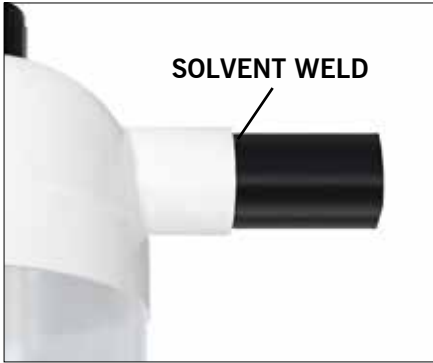

STEP 5: Take the second 100mm length of 1½" connector pipe and solvent weld it into the outlet of the Tempest filter. Push pipe into the outlet until it stops.

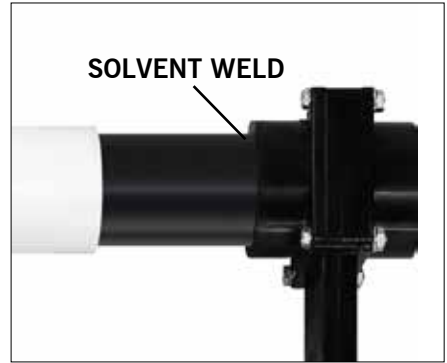

STEP 6: Solvent weld the slide valve onto the opposite end of the 1½" connector pipe. Push slide valve onto pipe until it stops.



STEP 7: Allow the glue to set for atleast 5 hours.

The Tempest is now set-up ready for installation.

The slide valves fitted allow connection to 1½" pressure pipe. If installing the Tempest Filter using flexible hose you will need to fit a reducing sleeve (**EA Code: M35-050**) and a 1½" solvent stepped hosetail (**EA Code: HOSETAIL15**) inside each slide valve.



TEMPEST FILTER INSTALLATION IDEAS

FLOW RATES

To allow the Tempest filter to give the best performance, it is important that the flow rate is no more than the **5,000 litres per hour**. These installation examples show a by-pass that will enable you to increase the flow through the pond.

TYPICAL INSTALLATIONS WITH A FILTER

Install a Tempest Filter after a primary filter on a **GRAVITY FED SET-UP**, such as the **Nexus+**, and after a UV Clarifier, such as an evoUV. The slide valves on the Tempest Filter enable connection to 1½" pressure pipe.

The installation example shown below has a by-pass that will enable you to increase the flow through your pond while maintaining the optimum flow through the Tempest Filter. Installing ball valves on the pipe work will help you regulate the flow. The return from the Tempest can go back to the centre of your **Nexus+** or back into the pond.

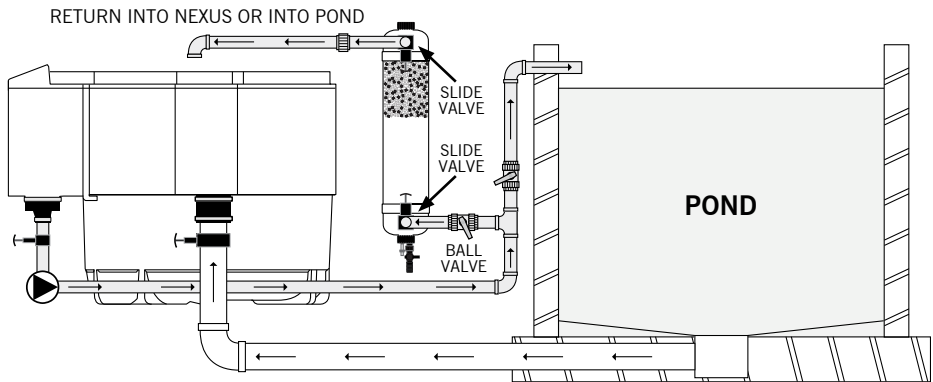

IMPORTANT: Ensure slide valves are fitted to inlet and outlet of the Tempest filter.



IMPORTANT: We always recommend fitting unions when installing in line equipment on your system which help when removing the filter.



IMPORTANT: Optimum flow rate through the Tempest filter is 5,000 LPH / 1,100 GPH / 1,320 US GPH

TEMPEST FILTER INSTALLATION IDEAS

TYPICAL INSTALLATIONS WITH A FILTER

Installed on a pressurised system with a K1 Micro Bead, **Nexus+**, EazyPod.
The slide valves on the Tempest Filter enable connection to 1½" pressure pipe.

The installation example shown below has a by-pass that will enable you to increase the flow through your pond while maintaining the optimum flow through the Tempest Filter. Installing ball valves on the pipe work will help you regulate the flow. The return from the Tempest and the K1 Micro Bead go back to the pond.

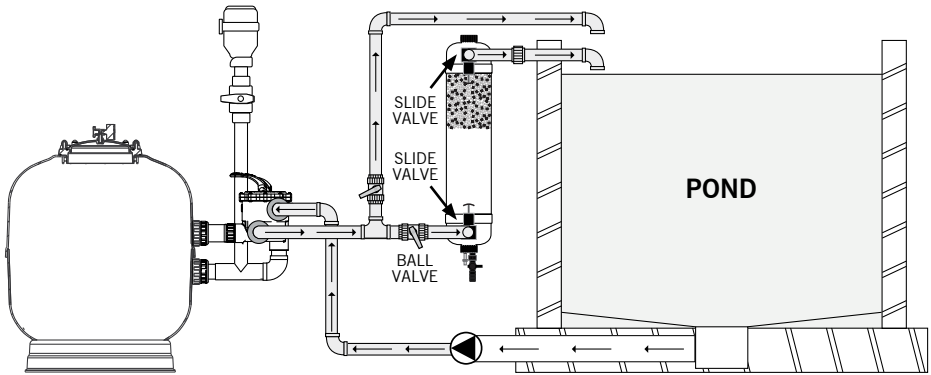

IMPORTANT: Ensure slide valves are fitted to inlet and outlet of the Tempest filter.



IMPORTANT: We always recommend fitting unions when installing in line equipment on your system which help when removing the filter.



IMPORTANT: Optimum flow rate through the Tempest filter is 5,000 LPH / 1,100 GPH / 1,320 US GPH

TEMPEST FILTER INSTALLATION IDEAS

TYPICAL STANDALONE TEMPEST FILTER INSTALLATIONS

Install a Tempest Filter on a quarantine system, or a standalone pond up to 5,000 litres, at the side of a pond or above the pond. The slide valves on the Tempest Filter enable connection to 1½" pressure pipe. If installing the Tempest Filter using flexible hose you will need to fit a reducing sleeve (**EA Code: M35-050**) and a 1½" solvent stepped hosetail (**EA Code: HOSETAIL15**) inside each slide valve.

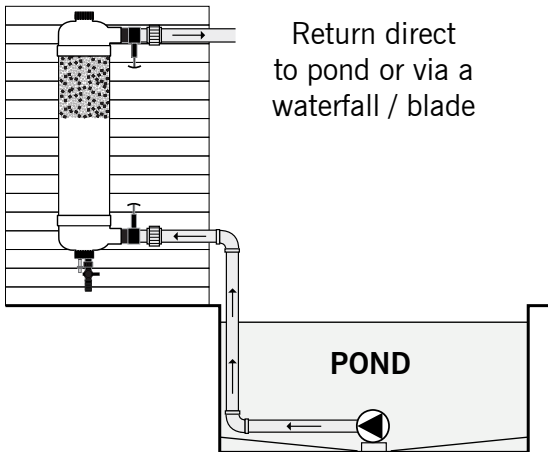
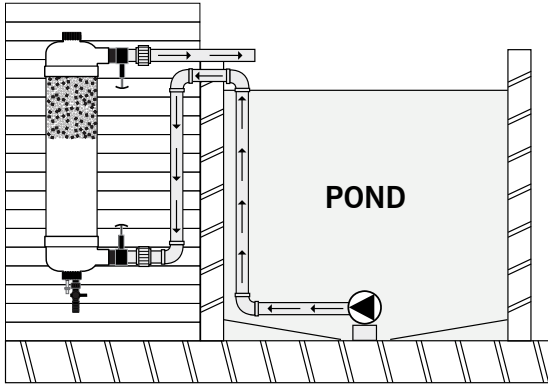

OPTIMUM FLOW RATE:
5,000 LPH
1,100 GPH
1,320 US GPH



IMPORTANT: Ensure slide valves are fitted to inlet and outlet of the Tempest filter.



IMPORTANT: We always recommend fitting unions when installing in line equipment on your system which help when removing the filter.

TEMPEST FILTER INSTALLATION IDEAS

SKIMMER LINE INSTALLATION

Install a Tempest Filter on a skimmer line.

The slide valves on the Tempest Filter enable connection to 1½" pressure pipe. If installing the Tempest Filter using flexible hose you will need to fit a reducing sleeve (EA Code: M35-050) and a 1½" solvent stepped hosetail (EA Code: HOSETAIL15) inside each slide valve.



**OPTIMUM
FLOW RATE:**
5,000 LPH
1,100 GPH
1,320 US GPH

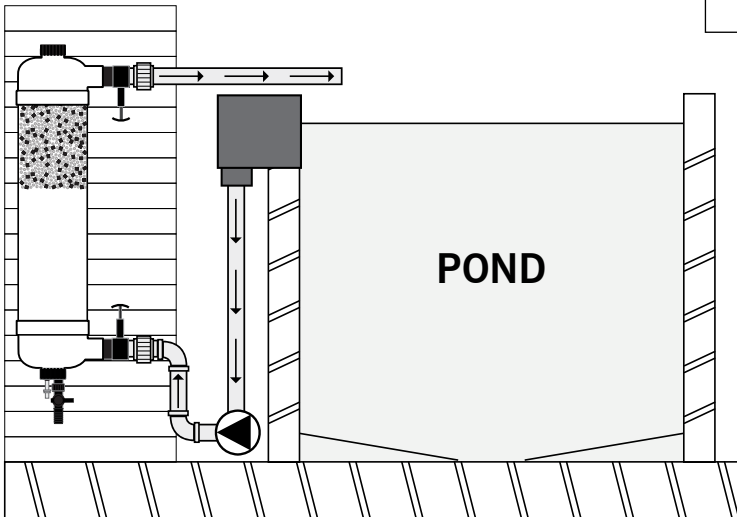

IMPORTANT: Ensure slide valves are fitted to inlet and outlet of the Tempest filter.



IMPORTANT: We always recommend fitting unions when installing in line equipment on your system which help when removing the filter.

TEMPEST FILTER INSTALLATION

MODULAR TEMPEST FILTER INSTALLATIONS

On larger systems that require a higher flow rate, multiple Tempest filters can be installed in a modular system. The slide valves on the Tempest Filter enable connection to 1½" pressure pipe. If installing the Tempest Filter using flexible hose you will need to fit a reducing sleeve (**EA Code: M35-050**) and a 1½" solvent stepped hosetail (**EA Code: HOSETAIL15**) inside each slide valve.



IMPORTANT: It is important that each Tempest can be isolated using the slide valves so that cleaning can be carried out independently.

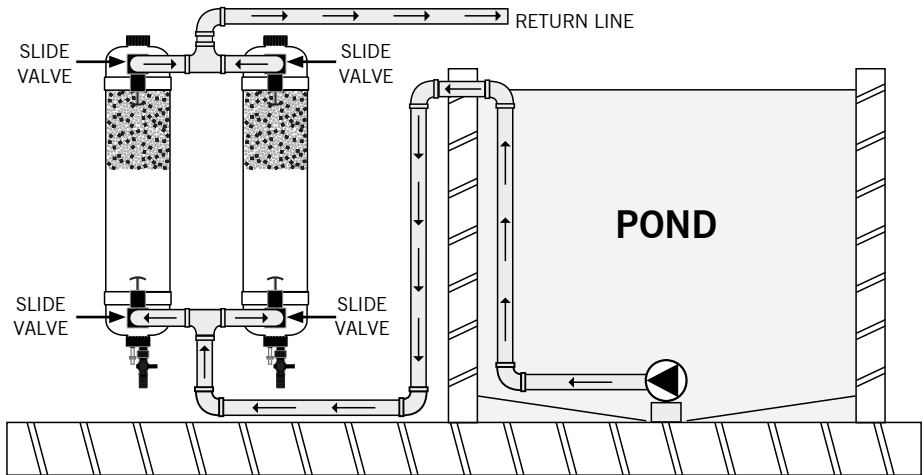

Although on the installation above we show two filters into one return line, independent return lines will allow you to observe the flow rate through both Tempest filters and balance accordingly.



IMPORTANT: We always recommend fitting unions when installing in line equipment on your system which help when removing the filter.



IMPORTANT: Optimum flow rate through each Tempest filter is 5,000 LPH / 1,100 GPH / 1,320 US GPH

TEMPEST FILTER INSTALLATION

The Tempest filter can **ONLY** be installed vertically with the waste air valve assembly at the bottom of the filter. You can choose to have the slide valves facing the left or right, depending on your set-up.



IMPORTANT: Only install the Tempest filter vertically, with the waste air valve assembly at the bottom of the filter.

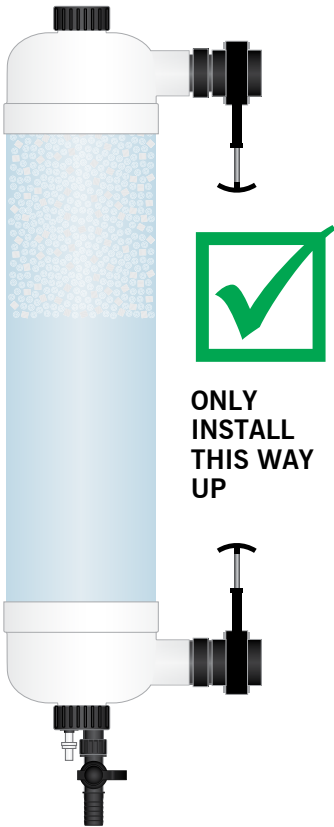

ONLY
INSTALL
THIS WAY
UP



NEVER INSTALL
HORIZONTALLY

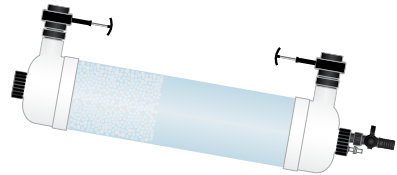

NEVER INSTALL
ON AN ANGLE



NEVER
INSTALL
UPSIDE
DOWN

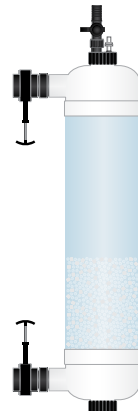

CAUTION

Approx. 30kg
when filled with
water



TEMPEST FILTER INSTALLATION

The Tempest filter can be mounted to a wall, wooden frame or timber post using the 1½" pipe clip brackets provided.



IMPORTANT: The filter will weigh approximately **30kg** when filled with water so ensure your fixing points can take the weight.



IMPORTANT: Always plan out your installation prior to gluing any pipework or fittings.

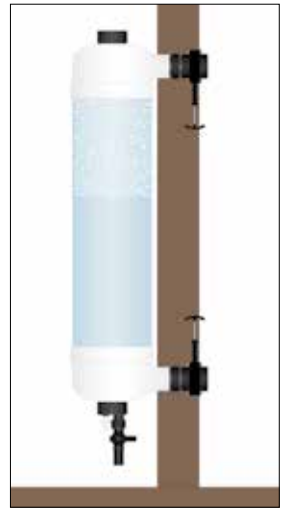
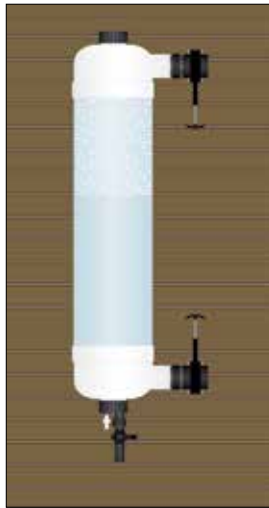
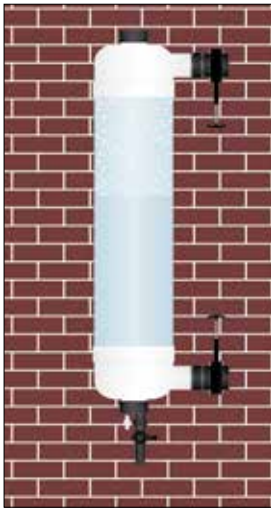

TEMPEST FILTER INSTALLATION

The 1½" pipe clip brackets will clip onto the connector pipe you have glued into the inlet and outlet. Locate the pipe clip brackets between the slide valves and the filter.

Find a suitable location to install the filter.

You will need to fit a block of wood or a similar spacer to which the pipe clip bracket can be screwed. This allows the filter to stand off from the surface of the wall.

Use a spirit level to check the filter is vertical.

Ensure you have enough room underneath the waste valve assembly to be able to turn the valve and to connect 1" hose to drain the water to waste.

Mark the locations and double check them before fixing.

Use appropriate screws and wall fixings to fix the pipe clip brackets and the spacer to your wall.

Once happy the pipe clip brackets are secure, locate the Tempest filter into the clips and fit the pipe clip bracket cover.

Your Tempest filter is ready to be connected up to your pipe work from your filter and back to your pond using 1½" pressure pipe work (not supplied). If you prefer to use 1½" hose you will need to purchase a Pressure Pipe to Waste Pipe Reducing Sleeve (EA CODE: **M35-050**) and 1½" Solvent Weld Hosetail (EA CODE: **HOSETAIL15**).

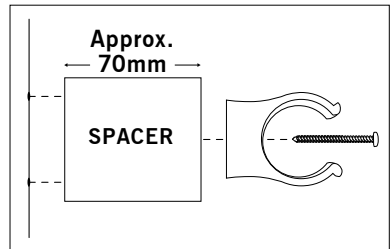
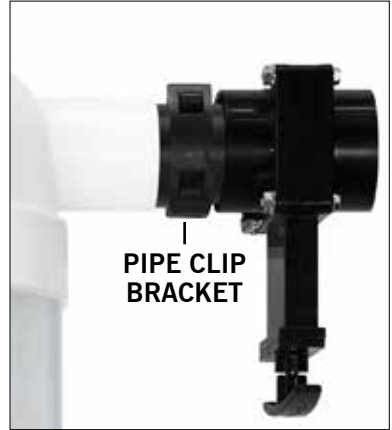

TEMPEST FILTER INSTALLATION

Follow these instructions to set-up your Tempest filter ready for installation.



IMPORTANT: The filter will weigh approximately **30kg** when filled with water so ensure your fixing points can take the weight.



IMPORTANT: Always plan out your installation prior to gluing any pipework or fittings.

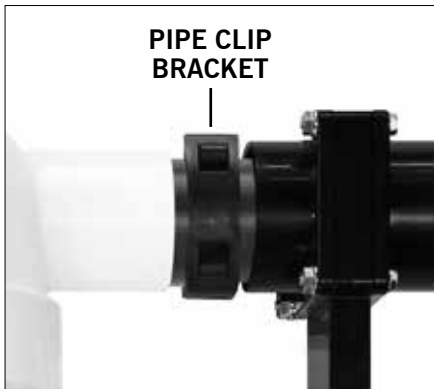

The pipe clip brackets should be located on the pipe between the slide valve and the inlet / outlet.



A spacer of approx. 70mm deep is needed to allow the filter to stand off the wall.



Use appropriate screws and fixings to securely hold the spacers and pipe clip brackets in place. Ensure these are aligned correctly.



Make sure there is enough room at the bottom of the filter to allow you to drain the filter to waste. You can fit hose onto the waste hoesetail.

CLEANING THE TEMPEST FILTER

The Tempest filter should be cleaned regularly as required. A cleaning process drops 25 litres of water to waste.



IMPORTANT: The pump must be turned off and slide valves closed before opening the tap on the waste valve assembly.



IMPORTANT: Ensure there is a way of disposing the waste water before cleaning.



IMPORTANT: On modular filter installations, with more than one tempest filter, ensure all filters are isolated and cleaned independently.

STEP 1: Switch pump off.

STEP 2: Close all slide valves on inlet and outlet.

STEP 3: Open the tap(s) on the waste valve assembly. Air enters the filter causing the filter media to move and clean as the water drains to waste.

STEP 4: Once the water has emptied from the filter(s) and the media sinks to the bottom, close the tap(s) on the waste valve assembly.

STEP 5: Open all slide valves on inlet and outlet.

STEP 6: Turn pump back on. Water will re-fill the tube and media will rise to the top.

STEP 7: Repeat this procedure, if necessary, switching the pump off just before the water reaches the top of the filter. This prevents water going back into the pond during the cleaning cycle.

TROUBLESHOOTING

If the media does not agitate well during the cleaning process:

1. Check the air valve is not blocked.
2. Check the slide valves are fully closed.
3. If the media is very dirty this may cause the pack to clump together. Multiple cleans should clear this.
4. If the white end cap at the bottom of the filter is full of waste it is possible to clear this by switching off the pump and unscrewing the waste valve assembly, allowing the blockage to clear.

CLEANING THE TEMPEST FILTER



1. Switch pump off



2. Close all slide valves



3. Open waste valve tap

Air enters the filter causing the filter media to move and clean as the water drains to waste.



4. Close waste valve tap

All the water should have emptied from the filter and the media will be at the bottom.

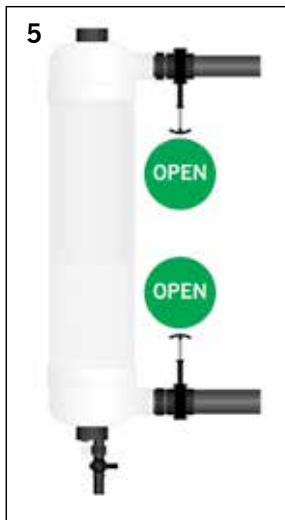

5. Open all slide valves



6. Switch pump on

Water will re-fill the tube and media will rise to the top. Normal filtration resumes.

TROUBLESHOOTING

Filter media not cleaning

1. Check the air valve is not blocked.
2. Check the slide valves are fully closed.
3. If the media is very dirty this may cause the pack to clump together. Multiple cleans should clear this.
4. If the white end cap at the bottom of the filter is full of waste it is possible to clear this by switching off the pump and unscrewing the waste valve assembly, allowing the blockage to clear.

Filter media not agitating freely

It will take a few days before the media starts to behave as it should. During this time it is likely to clump together and not agitate freely during cleaning. This will only last a few days.

Waste water does not drain when the tap on the waste valve assembly is open

The white end cap at the bottom of the filter may be full of waste. It is possible to clear this by switching off the pump and unscrewing the waste valve assembly, allowing you to clear the blockage.

Waste valve assembly is leaking

Check o-ring is seated correctly inside waste valve assembly

GUARANTEE

This product is guaranteed against defects in material and workmanship for 2 years from the date of purchase, under normal usage. The guarantee DOES NOT APPLY in case of improper use, negligence, lack of maintenance or accidental damage to the Tempest filter. If the Tempest fails due to a manufacturing fault within this period it will be either repaired or replaced free of charge. Liability is limited to replacement of the faulty product only; no other costs will be reimbursed. This guarantee is not transferable and does not affect your statutory rights. This guarantee does not confer any rights other than those expressly set out above.

The manufacturer or supplier shall not be responsible, or held liable for any damages caused by defective components or materials of this product; or for loss incurred by interruption of service; or any consequential/incidental damages and expenses arising from the production, sale use or misuse of this product or any other consequential loss.

Any warranty claim must be accompanied by a valid, dated proof of purchase.

Evolution Aqua and its dealers shall not be held liable for any loss of fish, plants or any other livestock as a result of any failure or defect of this product.

The installation and use of your product outside of our recommendations as printed in this manual may also void the warranty.

REGISTER YOUR WARRANTY ONLINE

The easiest way to register your warranty is to visit our website online at
www.evolutionaqua.com/product-warranty

If you prefer to post your warranty form, complete the details below and send it to:

Evolution Aqua, Kellet Close, Wigan, Lancashire, WN5 0LP

or scan and email it to

marketing@evolutionaqua.com

Evolution Aqua Tempest Warranty Form

NAME:

ADDRESS:

POSTCODE:

COUNTRY:

EMAIL:

PRODUCT: Tempest Filter

PURCHASED FROM:

DATE OF PURCHASE:

SIGNED:

DATE:

VISIT OUR WEBSITE AND FOLLOW US ON SOCIAL MEDIA



For all the latest Evolution Aqua news sign up to our email newsletter to have the newest info delivered direct to your inbox. Keep up to date by following us on social media, join our Pond Owners Club on Facebook or check out our website for technical information and product advice at www.evolutionaqua.com.



INSTRUCTION MANUALS

Download instruction manuals for all Evolution Aqua products



PARTS STORE

Find spare parts and accessories for Evolution Aqua products



FAQS

Read frequently asked questions about Evolution Aqua products



TECHNICAL ADVICE

Email us at info@evolutionaqua.com for further product support



STOCKISTS

Locate your nearest Evolution Aqua product stockist



EA POND OWNERS CLUB

Search Evolution Aqua Pond Owners Club on Facebook to join the community



FACEBOOK

Keep updated with our latest news at facebook.com/evolutionaqua



TWITTER

Follow us on Twitter for updates at twitter.com/evolutionaqua



INSTAGRAM

Follow us on Instagram for updates at instagram.com/evolution_aqua



YOUTUBE

Watch our YouTube channel at youtube.com/evolutionaqua

Evolution Aqua Ltd

Kellet Close
Wigan
Lancashire
United Kingdom
WN5 0LP

www.evolutionaqua.com

EVOLUTION
AQUA

INNOVATION IN WATER